

FOR INDOOR USE ONLY

SECTION VI. TIPS ON USE

When being introduced to the PIONEER PET® Rain Drop Fountain, your pet may be cautious of this new source of water. After beginning operation of the fountain, allow your pet to adjust at his or her own pace. Some pets take a few days or sometimes a little longer to begin use.

Your pet may prefer that the fountain be placed away from their normal feeding area. Try plugging it in somewhere else, like the laundry room, bathroom or another corner of the kitchen.

In some cases, let the fountain sit unplugged until your pet starts to drink. Later, you can plug the fountain in so that the water maintains its freshness.

SECTION VII. WARRANTY

Motor and Fountain Parts

The motor assembly and fountain parts are warranted to be free of defects in material and workmanship for one (1) year from the date of purchase. However, if proper pump maintenance is not followed per page 9 of this instruction manual the warranty will be voided. Retain your dated sales receipt as proof of purchase. For more information regarding product warranty or technical support submit email to: info@pioneerpet.com or call: 1-866-317-6278.

PIONEER PET® RAIN DROP FOUNTAIN

INSTRUCTIONS PERTAINING TO RISK OF FIRE, ELECTRICAL SHOCK OR HARM TO PERSONS

IMPORTANT SAFETY INSTRUCTIONS

WARNING: When using electrical appliances, basic precautions should always be followed, including the following:

Read the instructions thoroughly before using appliance.

To reduce the risk of injury, close supervision is necessary when an appliance is used near children.

Only use attachments recommended or sold by the manufacturer.

Do not use outdoors. **FOR INDOOR USE ONLY.**

Do not unplug by pulling on the power cord. To unplug, grasp the plug, not the power cord.

Do not operate any appliance with a damaged cord or plug, or after the appliance malfunctions or is dropped or damaged in any manner.

For portable appliance-To reduce the risk of electrical shock, do not place or store where it can fall or be pulled into a tub or sink.

Always unplug any appliance when not in use, before putting on or taking off parts, and before cleaning. Never pull power cord to remove from outlet.

SAVE THESE INSTRUCTIONS

SECTION I. OPERATING INSTRUCTIONS FOR YOUR PIONEER PET[®] RAIN DROP FOUNTAIN

DO NOT RUN DRY FOR INDOOR USE ONLY

As with any electrical device, check the electrical cord for any tears or damage before use.

1. Rinse the filter cartridge thoroughly under cool water before placing into the pump housing. Rinsing will remove a majority of the loose charcoal dust which is harmless to pets.

2. Remove the top bowl by placing your index fingers underneath front side of the top bowl and lift up from lower bowl. (Figure 1) Set top bowl off to the side.

3. Remove the top cover of pump housing by pulling the button on the front and pull up the cover (Figure2). After rinsing, insert the charcoal filter cartridge into the pump housing. The filter cartridge will fit into the frame of pump housing (Figure3)

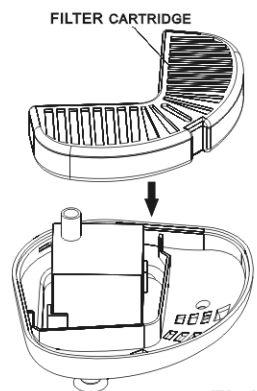
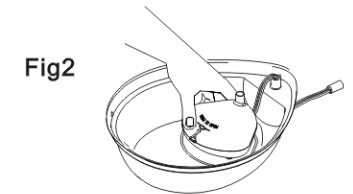
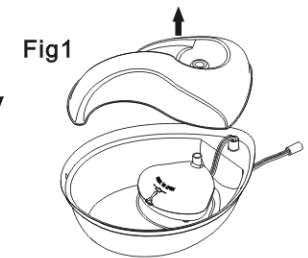

4. Put the top cover of pump housing in place. (Figure 4)

5. Put the top bowl in place.(Figure 5)

6. Place fountain in desired location.
The use of a protective mat is suggested to protect your floor from splashes or drips which may occur during use by your pet.

7. Fill the unit with water.

8. Before you plug in the fountain, make sure the cord and your hands are dry.

9. Please allow 1 to 2 minutes for pump to start pumping once plugged in.

10. Add water as needed and always keep fountain filled with water to 1/2 inch from top edge of the bowl.

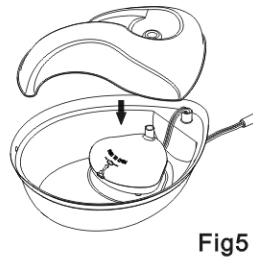
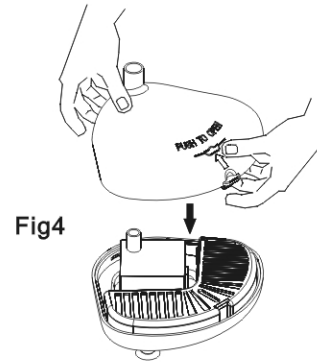

SECTION II. CLEANING AND MAINTENANCE INSTRUCTION FOR YOUR PIONEER PET[®] RAIN DROP FOUNTAIN

The Fountain Must Be Cleaned Regularly. Cleaning Frequency Depends Upon Number of Pets Using the Fountain and Quality of Your Water

FILTERS:

Filter cartridges should be changed approximately every two to four weeks. FOR REPLACEMENT FILTER CARTRIDGES PURCHASE PART #3002 UNIVERSAL REPLACEMENT FILTER (3PACK) ON LINE AT WWW.PIONEERPET.COM

FOUNTAIN:

Disassemble and clean the fountain approximately every one to two weeks using the following steps:

1. Unplug the fountain.

2. Remove the top bowl (Figure6).

3. Unplug the power cord from the transformer .

4. Pull out the power cord of motor from the power cord riser. Remove the pump housing and set aside (Figure7).

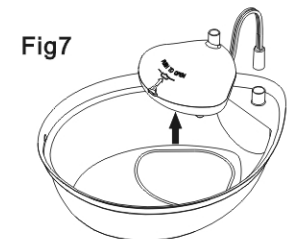
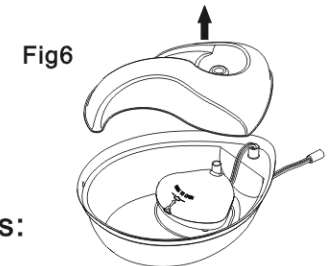

5. Pour out remaining water from the bottom bowl.
6. Remove power cord and motor and set aside.
7. Wash lower bowl and top bowl with a warm water, mild soap solution and rinse well.
8. Dry all fountain components with a clean towel.

SECTION III. REASSEMBLING AND RESTARTING YOUR FOUNTAIN AFTER CLEANING

1. Make sure the motor flow rate lever is set to the second lowest position. (Figure8)

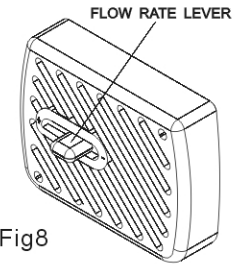

Fig8

2. Change filter cartridge (please replace any filter cartridge over four weeks old). If using a new filter cartridge, first rinse the filter cartridge before use.

3. Install the top cover of pump housing.



Fig9

4. Re-install the pump housing in guides located in the inside of the lower bowl. Press pump housing down to allow the suction cups to attach to the bowl. (Figure9)

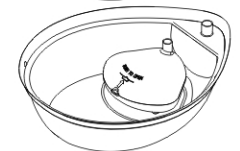

5. Thread the power cord through the power cord riser (Figure 10)

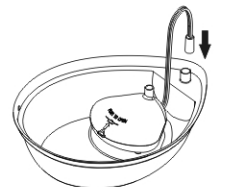
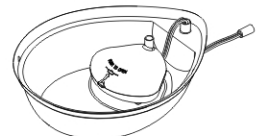

Fig10

6. Install the top bowl of fountain.



7. Place fountain in desired location. The use of a protective mat is suggested to protect your floor from splashes or drips which may occur during use by your pet.

8. Fill the unit with water.

9. Plug the power cord with transformer.

10. Before you plug in the fountain, make sure the cord and your hands are dry.

11. Add water as needed.

SECTION IV. MOTOR MAINTENANCE

Cleaning the motor is essential to the longevity of the fountain as well as the cleanliness of the water.

1. Unplug the fountain.

2. Remove the top bowl from the lower bowl.

3. Unplug the power cord from transformer.

4. Remove the top cover of pump housing and set aside.(Figure 11)

5. Gently lift the motor out of the cavity of pump housing. Suction cups on the bottom of the motor will hold it in place. A small amount of force may be necessary.

6. Once the motor is out of the fountain, with your thumb and forefinger, gently squeeze on either side of the intake plate, and pull off. It may be necessary to insert a fingernail into the seam of the inlet plate to pry it off. (Figure 12)

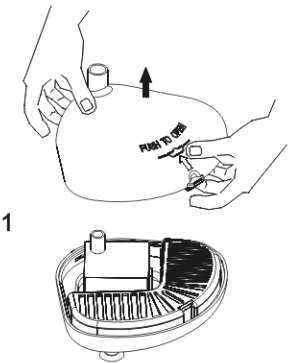

Fig11

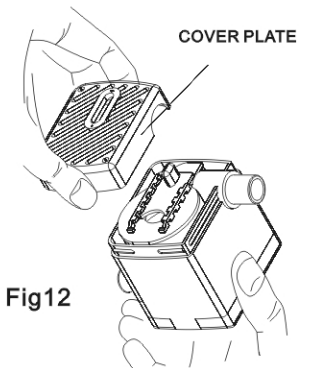

Fig12

7. Next you will need to remove the stator by placing your finger nail under the small lip located on the narrow side of tear drop shaped stator and pull out. (Figure 13)

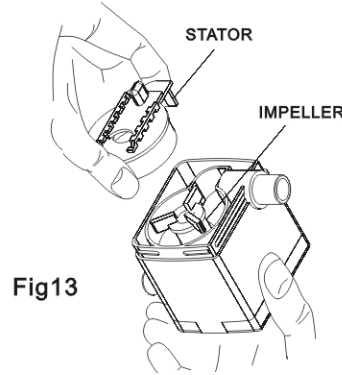

Fig13

8. Once the stator is removed you can also remove the impeller (three bladed propeller) which is held in place magnetically. To remove the impeller, use a fingernail to get under a blade and lift out. (Figure 14)

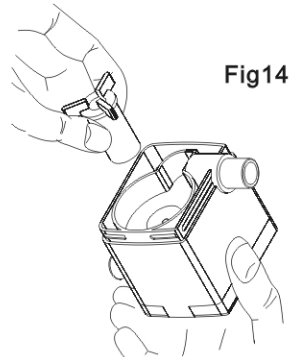

Fig14

9. Rinse well.

10. Once the parts are clean you can reassemble the motor for use by replacing the impeller, stator and cover plate.

SECTION V. MANUFACTURER'S SAFETY INSTRUCTIONS

INSTRUCTIONS PERTAINING TO RISK OF FIRE, ELECTRICAL SHOCK OR HARM TO PERSONS

Do not allow pets or children to chew on or swallow any fountain parts. If you are concerned about the power cord, purchase a cord conduit or cord cover at any home improvement or hardware store.

Do not attempt repairs on the motor yourself.

If the plug of this device gets wet, turn off the electricity to that outlet. Do not attempt to unplug.

To avoid the possibility of the plug or outlet getting wet, the outlet should always be above the level of the fountain.

Examine this appliance after installation. It should not be plugged in if there is water on the cord or plug.

Do not operate any appliance if it has a damaged cord or plug, or if it is malfunctioning or has been damaged.

If an extension cord is necessary, a cord with a proper rating should be used.